

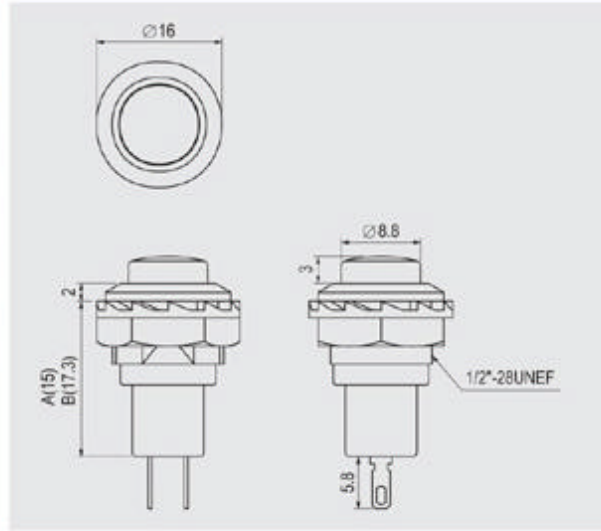

# R13-502









<b>Rating</b>
3A 125V AC 1.5A 250V AC
<b>Contact resistance</b>
50mΩ Max
<b>Insulation resistance</b>
DC 500V 100MΩ Min
<b>Dielectric strength</b>
AC 1000V 1 minute
<b>Cut-out</b>

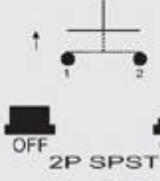

## FEATURES

- \* MATERIAL: Frames are nylon (UL flame: 94V-2). Terminals are silver plated brass.
- \* M types are metal frames, nickel plated brass.

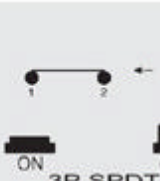
## R13-502

BODY	FUNCTION	TERMINAL
 Plastic Body 	<b>A</b>  OFF (ON)	<b>0 5</b>  SO
 Metal Body 	<b>B</b>  (OFF) ON	
	<b>C</b>  ON (ON) (Only for R13-502MC)	

